

Enjoy the

Power Store of renewable energy

HAI-TEC Power Store is developed based on newest CATL Technology.

This long life Product can be upgraded by parallel connection of several units of Power Store. So it has a wide range usage by commercial as well as privet sector.

By its 10 Years long life save money and time by almost stable productivity.

This energy storage is equipped with overcharging and over discharging detection functions.

It monitors temperature changes due to battery abnormal operation in sate of charging / discharging.

Maintenance can be easily conducted as the Power storage support RS 485 communications.

Power Storage has a cell balancing functions that reduces voltage gap among cells by consuming the energy of high voltage cell through heat.

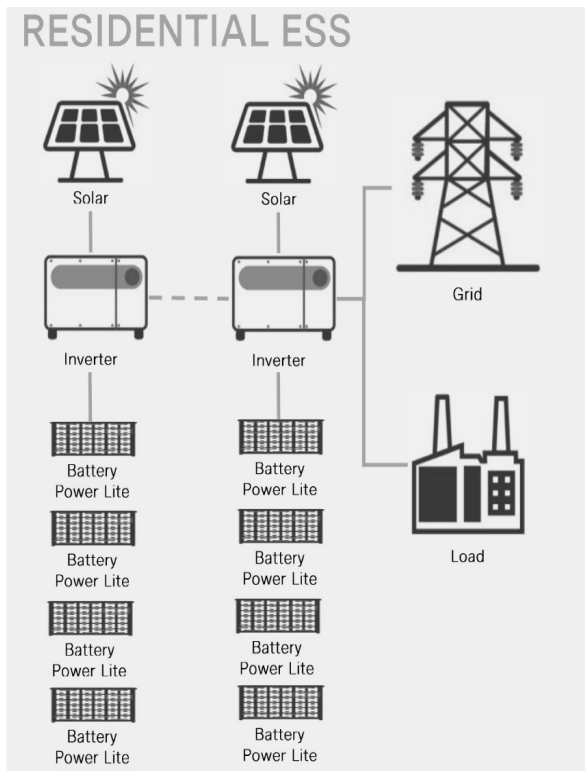

Connection

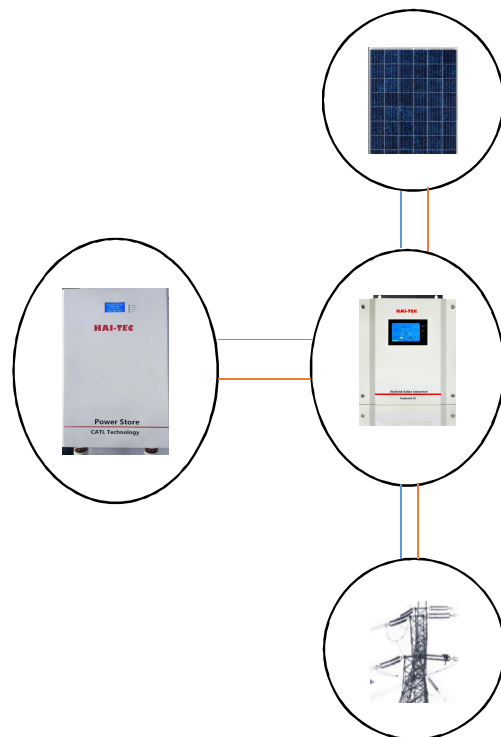

Performance

9,0 Performance Curve.

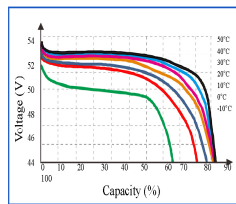
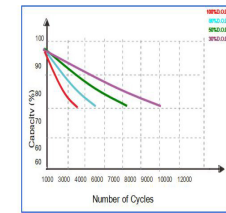

Self-discharge at different temperature

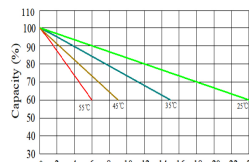

Temperature effects on capacity at 0.5C

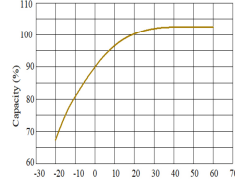

Dimension

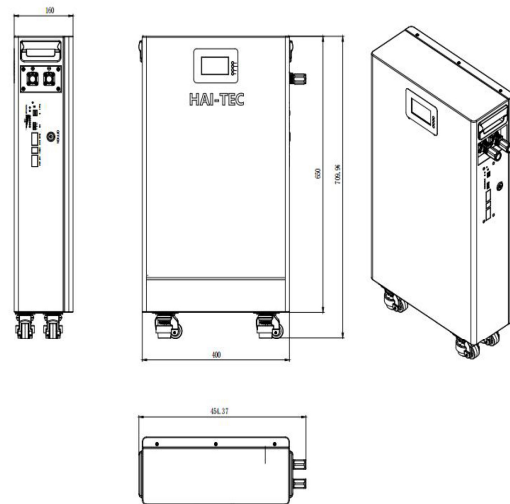

SPECIFICATION

Battery Enclosure	Value
Battery type	LiFePo4 Lithium Ion Battery
Nominal Battery Energy	5.12 KWh , expandable by parallel connection
Nominal capacity	100 Ah
Nominal voltage	51,2 V
Operating voltage	46.0 V – 56.0 V
Nominal charging voltage	57 V
Cut-off voltage	44 V
Rated charge / discharge current	20 A
Nominal charge current	50 A
Max. continuous discharging current	100 A
Dimension (W*D*H)	710*400*160 mm
Mounting	Rear fixing
Weight	46 Kg
Working temperature	By charging from -5 To +50 °C By discharging from -20 To +55 °C
Display	Yes
Communication	CAN / RS485 / RS232
Calendar life	10 year
Parallel connection	Yes
Moving wheels	Yes

